

Speech Signal Analysis 1

Hao Tang

Automatic Speech Recognition—ASR Lecture 2
20 January 2022

Announcement

- Please sign up for Piazza
(<https://piazza.com/ed.ac.uk/spring2022/infr11033>)
- No labs next week. The labs will start on week 3.

waveform



Signal Analysis

acoustic
features

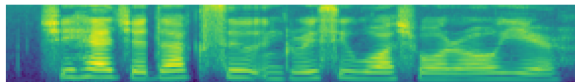

ASR system

waveform



- Speech is part of sound waves.
- If we want to study speech, we need to be able to record, replay, and visualize speech.

Phonautograph (1857)



Phonograph (1877)

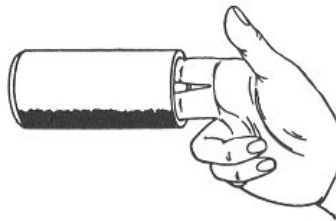

Carbon Microphone (1877)

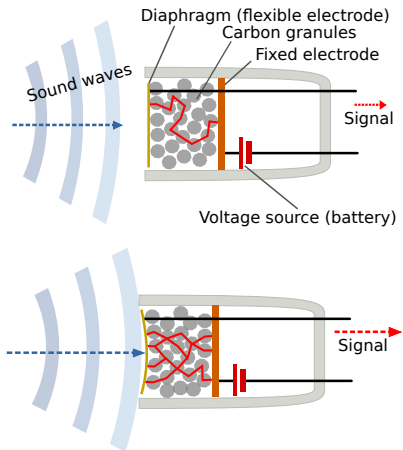

Wave Samples

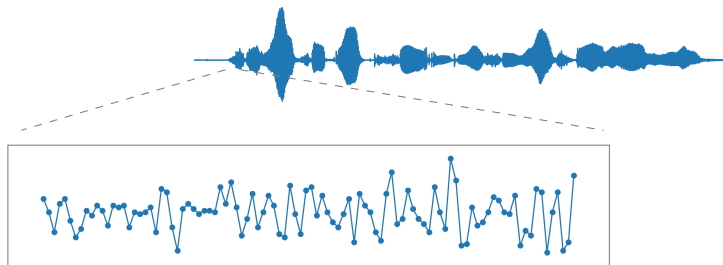

- Sound waves are sampled and quantized.
- The typical sampling rate is 16,000 Hz. Each sample is typically a 16-bit integer.
- We will use $x[t]$ to denote the t -th sample in the signal x .

Line Plots and Vectors

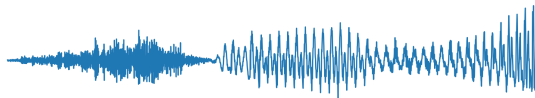

$[-0.53 \quad -0.32 \quad 0.02 \quad 0.44 \quad \dots \quad 0.18]$

Common Preprocessing in the Time Domain

- Dithering

$$y[t] = x[t] + \epsilon \quad \epsilon \sim \mathcal{N}(0, 1)$$

- Add a little Gaussian noise to the signal.
- Avoid the signal being zeros, since we will be taking logarithm at some point.

- Removing DC offset

$$y[t] = x[t] - \frac{1}{T} \sum_{i=1}^T x[i]$$

- Ensure that the signal has mean zero.
- Most processing assumes the signal to have zero mean.

- Pre-emphasis

$$y[t] = x[t] - 0.97 \cdot x[t - 1]$$

- Emphasize the high-frequency components.
- We will come back to this after we talked about frequency analysis.

Ohm's Acoustic Law (1843)



If you hear a pitch of a certain frequency, then there must be energy of that frequency present in the sound wave.

Periodicity in Speech

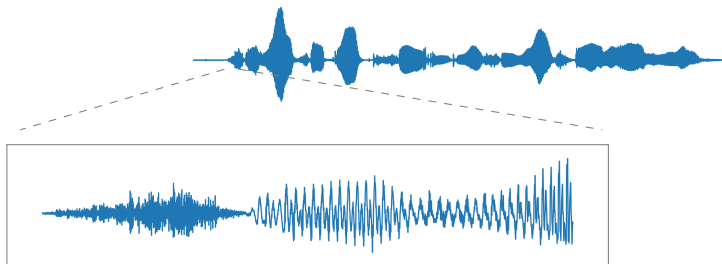

Periodicity in Speech

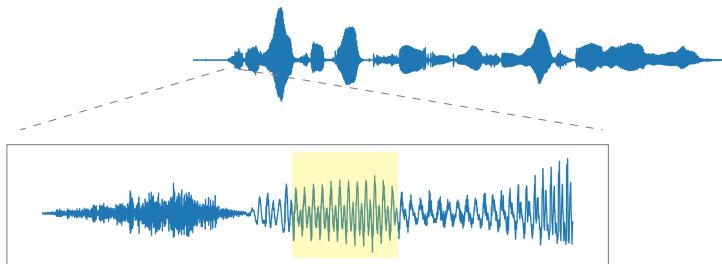

Discrete Fourier Transform

$$X[k] = \sum_{t=0}^{T-1} x[t]e^{-i2\pi tk/T} \quad \text{for } k = 0, \dots, T-1, \text{ and } i = \sqrt{-1}$$

Discrete Fourier Transform

$$X[k] = \sum_{t=0}^{T-1} x[t] e^{-i2\pi tk/T} \quad \text{for } k = 0, \dots, T-1, \text{ and } i = \sqrt{-1}$$

$$X[k] = \left[e^{i2\pi k \cdot 0/T} \quad e^{i2\pi k \cdot 1/T} \quad \dots \quad e^{i2\pi k \cdot (T-1)/T} \right]^* \begin{bmatrix} x[0] \\ x[1] \\ \vdots \\ x[T-1] \end{bmatrix}$$

Discrete Fourier Transform

$$X[k] = \sum_{t=0}^{T-1} x[t] e^{-i2\pi tk/T} \quad \text{for } k = 0, \dots, T-1, \text{ and } i = \sqrt{-1}$$

$$X[k] = \left[e^{i2\pi k \cdot 0/T} \quad e^{i2\pi k \cdot 1/T} \quad \dots \quad e^{i2\pi k \cdot (T-1)/T} \right]^* \begin{bmatrix} x[0] \\ x[1] \\ \vdots \\ x[T-1] \end{bmatrix}$$

$$v_k \triangleq \left[e^{i2\pi k \cdot 0/T} \quad e^{i2\pi k \cdot 1/T} \quad \dots \quad e^{i2\pi k \cdot (T-1)/T} \right]$$

$$e^{i\theta} = \cos \theta + i \sin \theta$$

Fourier Basis

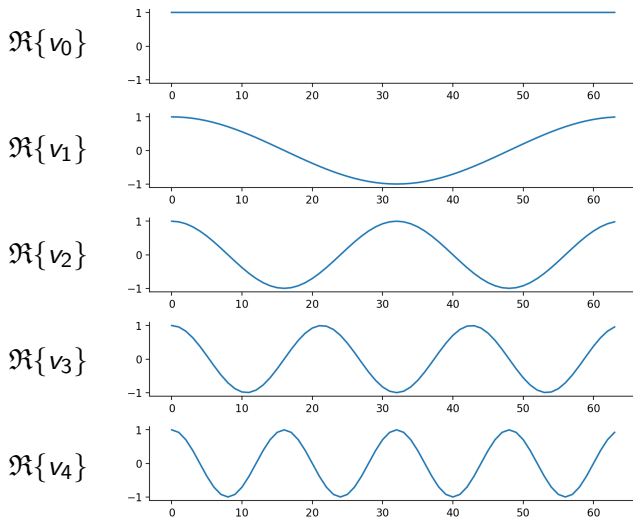

- The larger the k , the higher the frequency.

$$v_k = [e^{i2\pi k \cdot 0/T} \quad e^{i2\pi k \cdot 1/T} \quad \dots \quad e^{i2\pi k \cdot (T-1)/T}]$$

- The larger the k , the higher the frequency.

$$v_k = [e^{i2\pi k \cdot 0/T} \quad e^{i2\pi k \cdot 1/T} \quad \dots \quad e^{i2\pi k \cdot (T-1)/T}]$$

- The set $\{v_0/T, v_1/T, \dots, v_{T-1}/T\}$ is an orthonormal basis.

$$v_m^* v_n = \begin{cases} 0 & \text{if } m \neq n \\ T & \text{if } m = n \end{cases}$$

- The larger the k , the higher the frequency.

$$v_k = [e^{i2\pi k \cdot 0/T} \quad e^{i2\pi k \cdot 1/T} \quad \dots \quad e^{i2\pi k \cdot (T-1)/T}]$$

- The set $\{v_0/T, v_1/T, \dots, v_{T-1}/T\}$ is an orthonormal basis.

$$v_m^* v_n = \begin{cases} 0 & \text{if } m \neq n \\ T & \text{if } m = n \end{cases}$$

- Fourier transform is a change of coordinates.

Discrete Fourier Transform

$$X[k] = \sum_{t=0}^{T-1} x[t]e^{-i2\pi tk/T} = v_k^* x$$

- $X[k]$ is a complex number.
- $X[k]$ is a (complex) dot product of a complex sinusoid v_k and the signal x .
- $X[k]$ tells us how similar x is to v_k .
- The large k 's in X are high-frequency components, while the small k 's in X are low-frequency components.

Discrete Fourier Transform

$$X = \mathcal{F}\{x\}$$

- DFT decomposes a signal into frequency components.
- X is also called the spectrum of x .

Discrete Fourier Transform

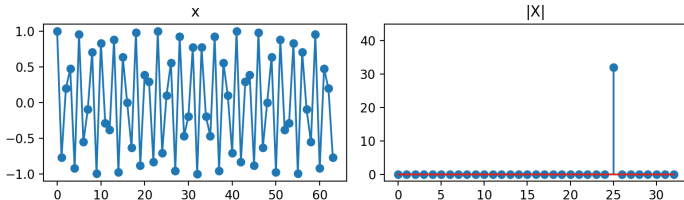
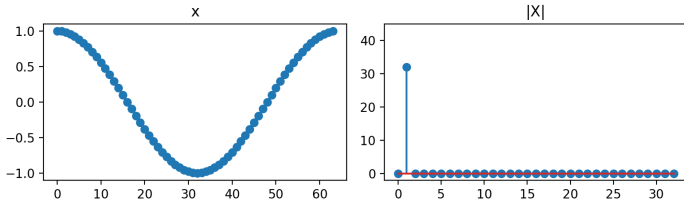

Discrete Fourier Transform

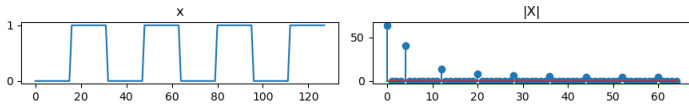

Discrete Fourier Transform

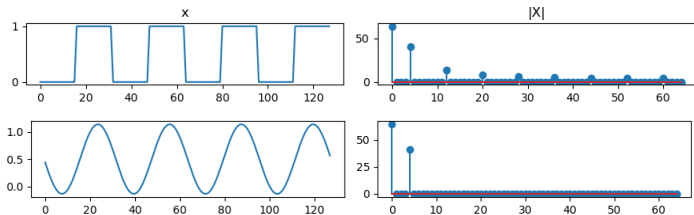

Discrete Fourier Transform

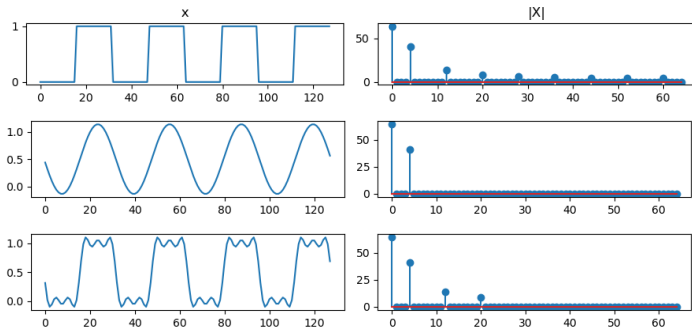

Discrete Fourier Transform

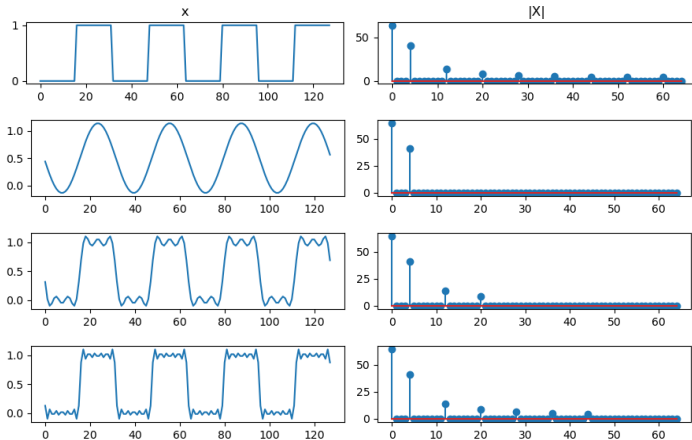

Discrete Fourier Transform

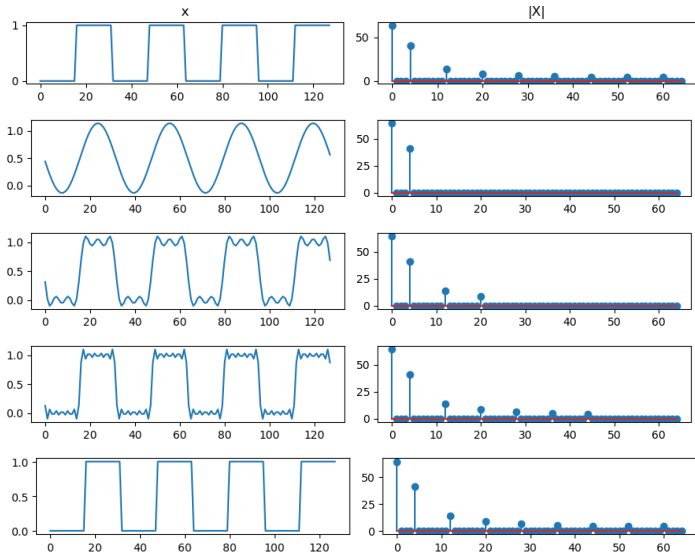

- Linearity

$$\mathcal{F}\{a_1x_1 + a_2x_2\} = a_1\mathcal{F}\{x_1\} + a_2\mathcal{F}\{x_2\}$$

- Linearity

$$\mathcal{F}\{a_1x_1 + a_2x_2\} = a_1\mathcal{F}\{x_1\} + a_2\mathcal{F}\{x_2\}$$

- Shift Theorem

$$\text{If } y[t] = x[t - 1], \text{ then } Y[k] = e^{i2\pi k/T}X[k].$$

Proof of the Shift Theorem

$$Y[k] = \sum_{t=0}^{T-1} y[t]e^{-i2\pi tk/T}$$

Proof of the Shift Theorem

$$\begin{aligned} Y[k] &= \sum_{t=0}^{T-1} y[t] e^{-i2\pi tk/T} \\ &= \sum_{t=0}^{T-1} x[t-1] e^{-i2\pi tk/T} \end{aligned}$$

Proof of the Shift Theorem

$$\begin{aligned} Y[k] &= \sum_{t=0}^{T-1} y[t] e^{-i2\pi tk/T} \\ &= \sum_{t=0}^{T-1} x[t-1] e^{-i2\pi tk/T} \\ &= e^{i2\pi k/T} \sum_{t=0}^{T-1} x[t-1] e^{-i2\pi(t-1)k/T} \end{aligned}$$

Proof of the Shift Theorem

$$\begin{aligned} Y[k] &= \sum_{t=0}^{T-1} y[t] e^{-i2\pi tk/T} \\ &= \sum_{t=0}^{T-1} x[t-1] e^{-i2\pi tk/T} \\ &= e^{i2\pi k/T} \sum_{t=0}^{T-1} x[t-1] e^{-i2\pi(t-1)k/T} \\ &= e^{i2\pi k/T} X[k] \end{aligned}$$

Pre-emphasis

- Definition

$$y[t] = x[t] - 0.97 \cdot x[t - 1]$$

Pre-emphasis

- Definition

$$y[t] = x[t] - 0.97 \cdot x[t - 1]$$

- DFT of pre-emphasis

$$\begin{aligned} Y[k] &= X[k] - 0.97 \cdot e^{i2\pi k/T} X[k] \\ &= (1 - 0.97 \cdot e^{i2\pi k/T}) X[k] \end{aligned}$$

Pre-emphasis

- Definition

$$y[t] = x[t] - 0.97 \cdot x[t - 1]$$

- DFT of pre-emphasis

$$\begin{aligned} Y[k] &= X[k] - 0.97 \cdot e^{i2\pi k/T} X[k] \\ &= (1 - 0.97 \cdot e^{i2\pi k/T}) X[k] \end{aligned}$$

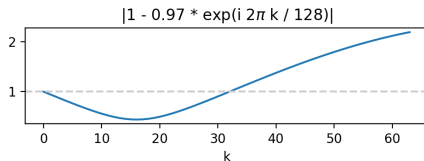

Pre-emphasis

- Definition

$$y[t] = x[t] - 0.97 \cdot x[t - 1]$$

- DFT of pre-emphasis

$$\begin{aligned} Y[k] &= X[k] - 0.97 \cdot e^{i2\pi k/T} X[k] \\ &= (1 - 0.97 \cdot e^{i2\pi k/T}) X[k] \end{aligned}$$

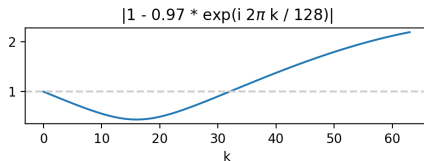

- In other words, pre-emphasis emphasizes the high-frequency region.

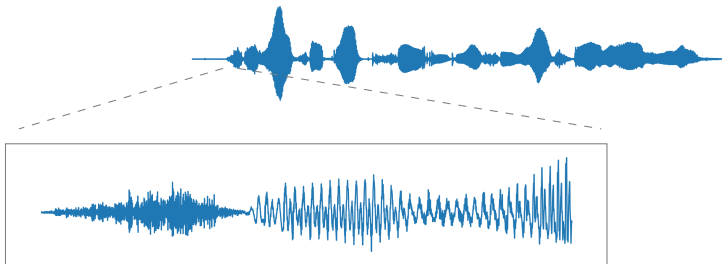

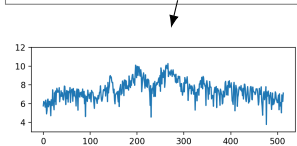
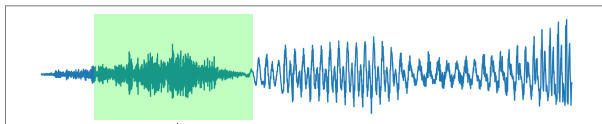
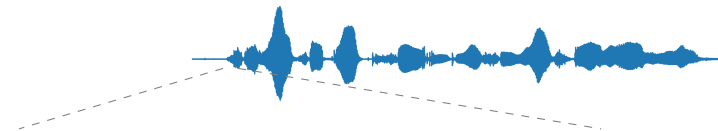

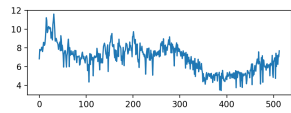
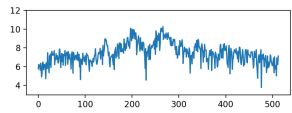
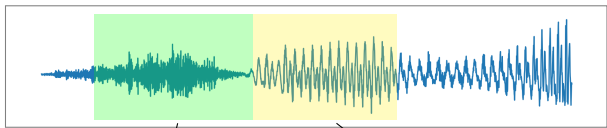
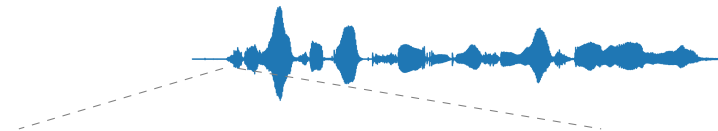

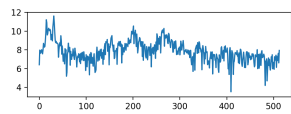
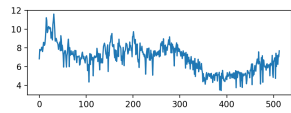
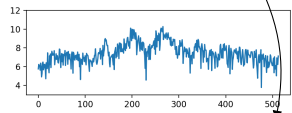
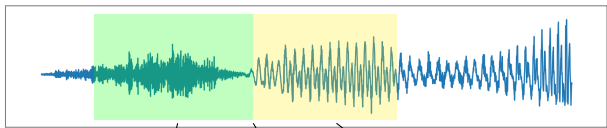
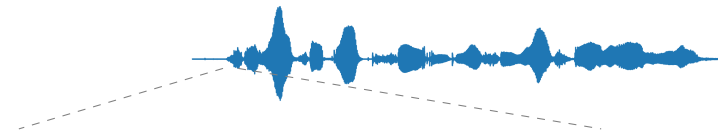

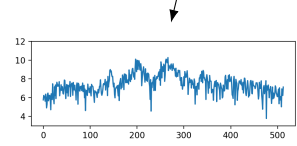
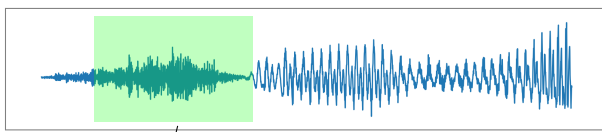
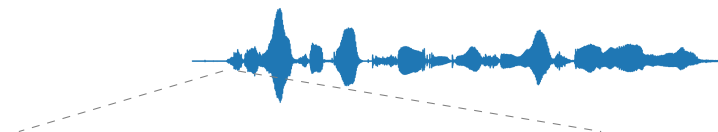

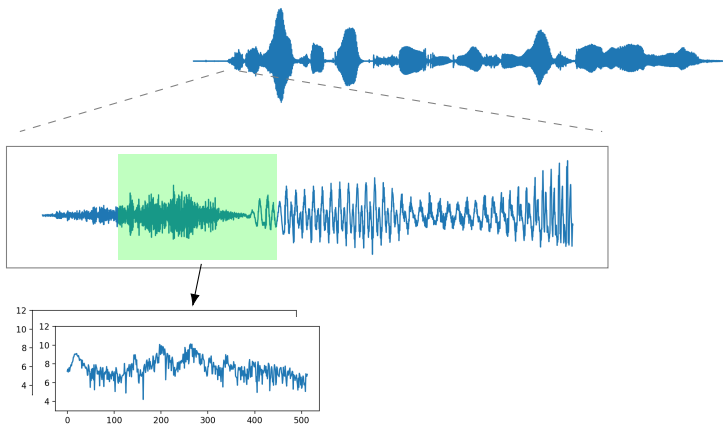

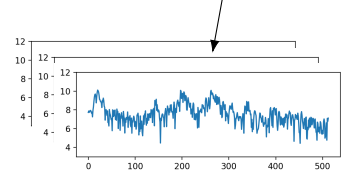
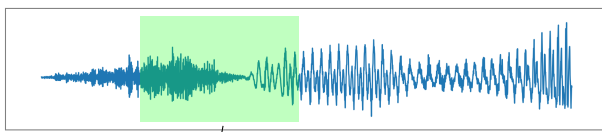
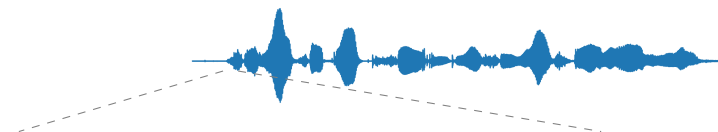

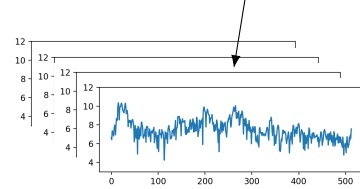
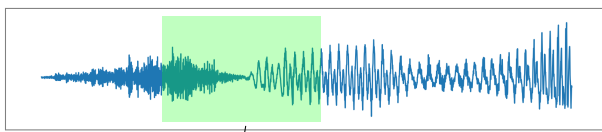
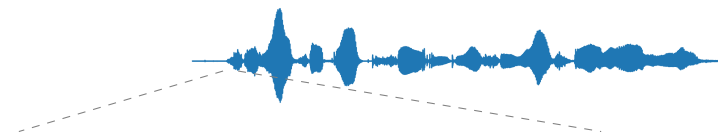

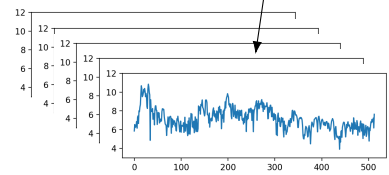
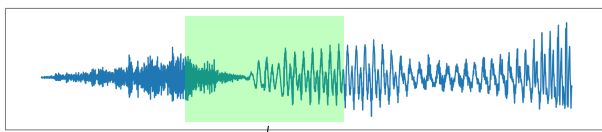
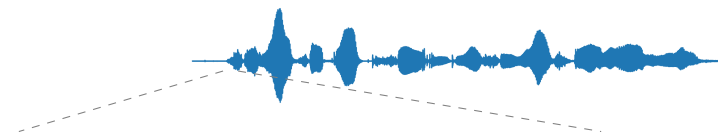

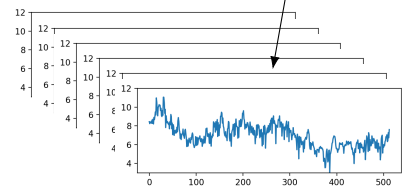
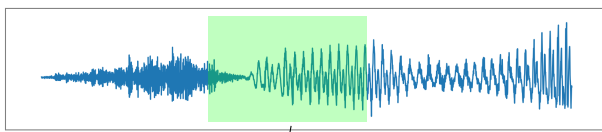
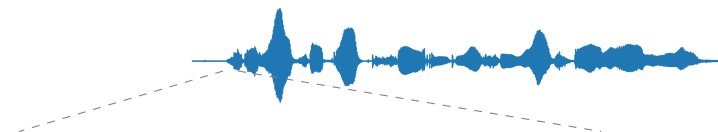

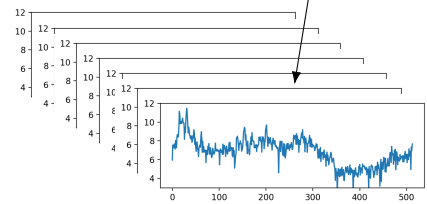
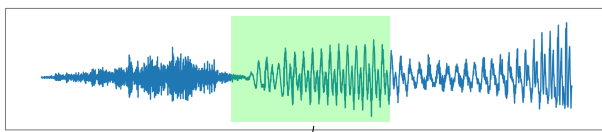
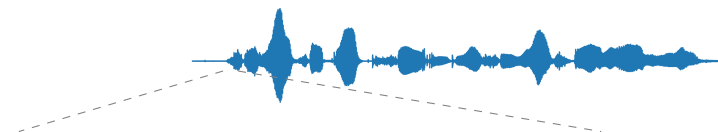

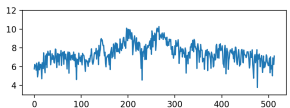

low
freq

high
freq

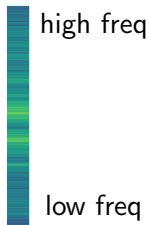

high freq

low freq

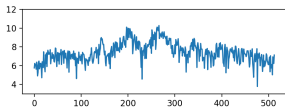

low
freq

high
freq

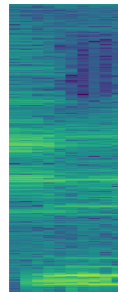
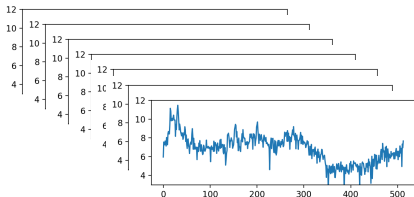
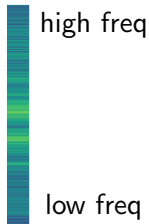

Short-Time Fourier Transform

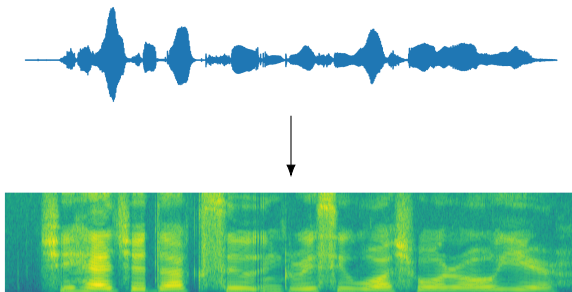

- Speech is non-stationary.
- Extract spectra with a sliding window, typically with a 25ms window size and a 10ms hop.
- Display the spectra as a heat map.

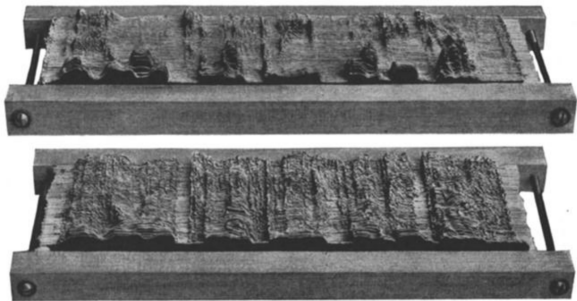
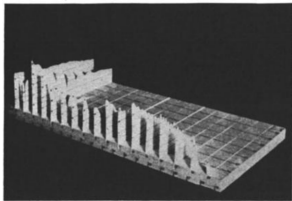
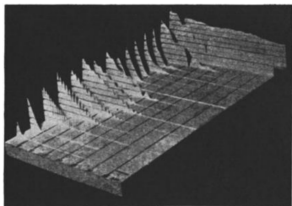

Sound Spectrograph (1946)

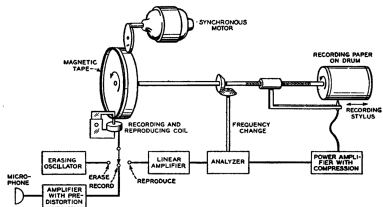
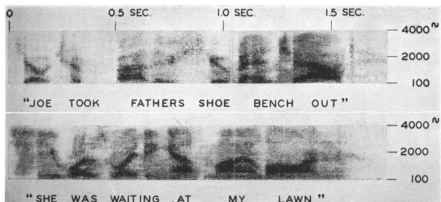

Fast Fourier Transform (1965)

- The algorithm that we know of today was proposed in 1965.
- It was applied to speech on a computer around 1969.

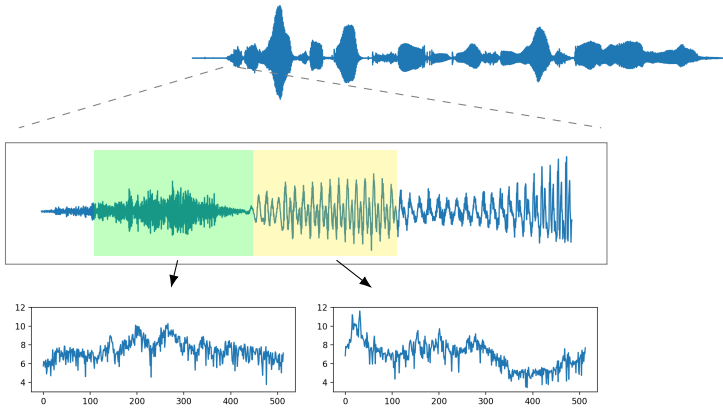

Windowing

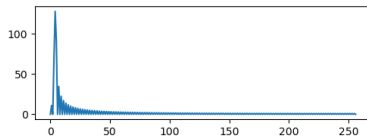
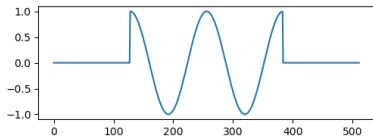
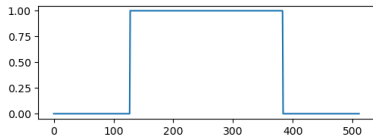
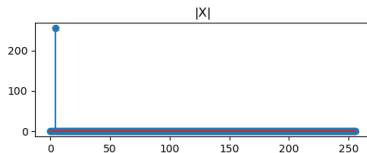
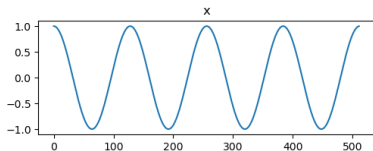

Windowing

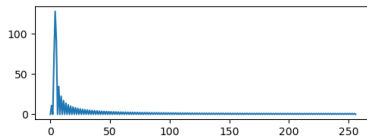
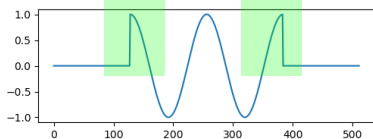
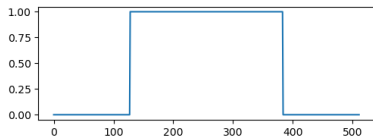
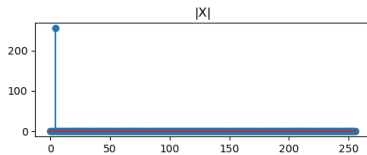
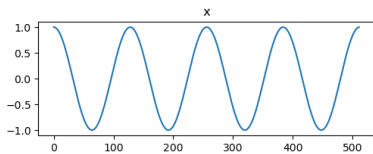

Windowing

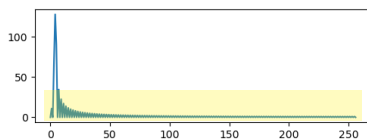
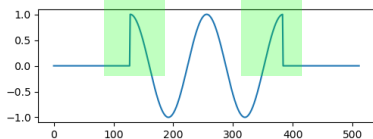
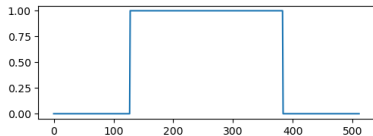
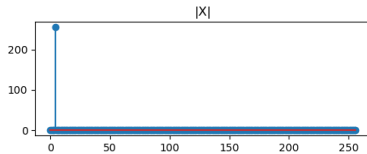
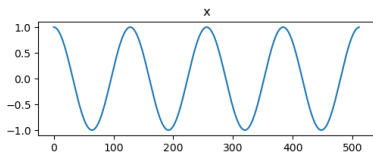

Windowing

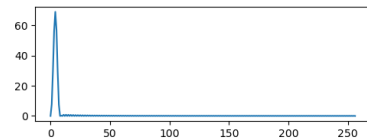
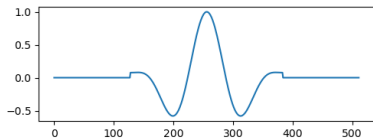
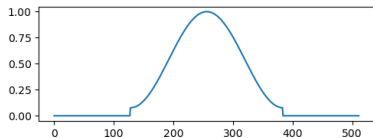
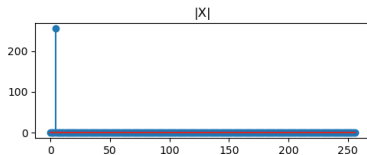
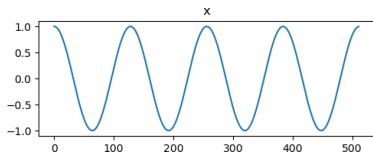

Windowing

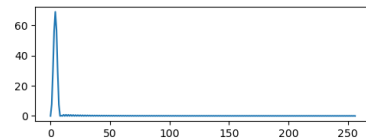
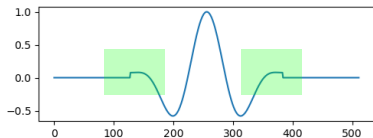
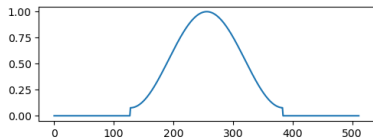
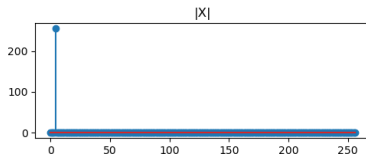
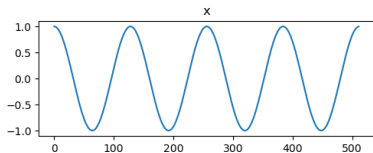

$$y[t] = x[t] \cdot w[t]$$

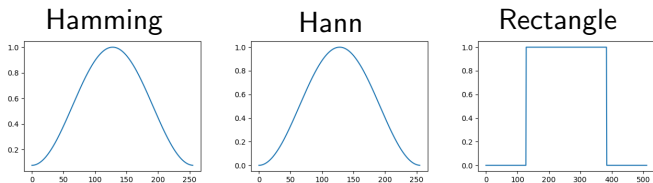

- The signal w is called a window.
- Windowing is elementwise product.

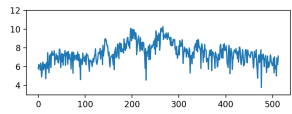
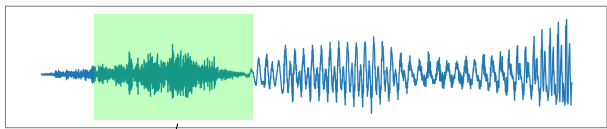
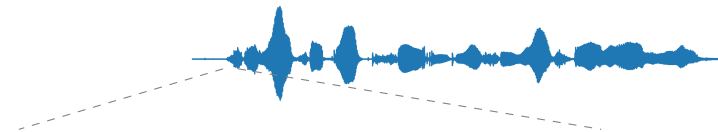

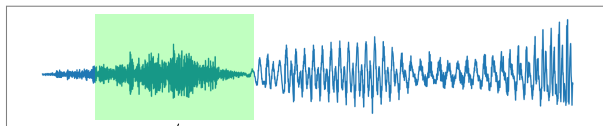
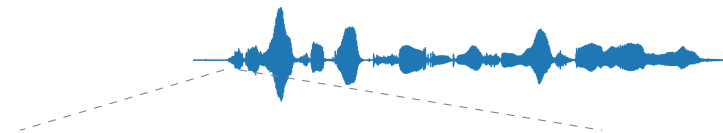

↓
windowing

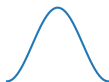

↓
DFT

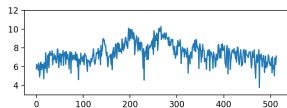

Spectrogram

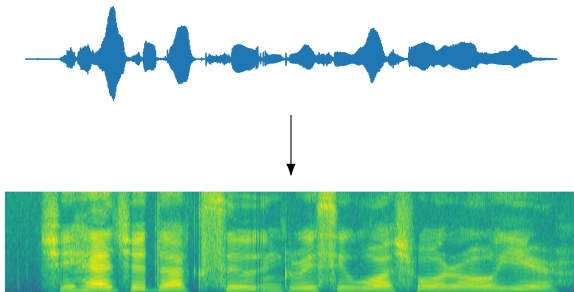

- dithering, removing DC offset, pre-emphasis
- windowing
- Discrete Fourier transform (DFT)
- Short-time Fourier transform (STFT)

Further Reading

- Chapter 1–5, Oppenheim, Willsky, and Nawab, “Signals and Systems,” 1997
- Chapter 2, O’Shaughnessy, “Speech Communications: Human and Machine,” 2000